

*Desoutter*



**Industrial** Tools



**Posco 500 Positioning System**  
**ECS Series Screwdriver**  
Advanced ergonomics  
and high-speed performance

**More Than Productivity**



# For all your screw tightening needs

---

**Desoutter ECS Series screwdrivers offer outstanding torque precision and operator ergonomics, making them the ideal choice for assembly line tasks that require a critical-level quality.**

## Unmatched speed

Featuring a torque range from 0.12 to 16 Nm, ECS Screwdrivers provide the fastest performance on the market. Higher RPMs means improved productivity by reducing the time it takes to accomplish each fastening operation. The maintenance-free brushless motor, long-life gears and on-board electronics provide smooth-start operation and precise torque levels. The ECS Series is ESD certified for use in electrostatically exposed areas.

## Advanced ergonomics

Operator comfort has a direct impact on assembly quality, so Desoutter engineers have paid special attention to the ergonomics into the ECS Series. Its reduced size and weight make it easy to handle for both male and female operators. It also features a soft rubber grip, ergonomic body shape and the choice of a push-to-start trigger or a long-start lever. The motor has been engineered to produce low noise levels at high speeds. And the tip of the tool is fitted with LED headlights to improve joint visibility.



---

### Precision control

Long-start lever

---

### ESD Certification

Electrostatic discharge component protection



---

### Precision control

Push-to-start

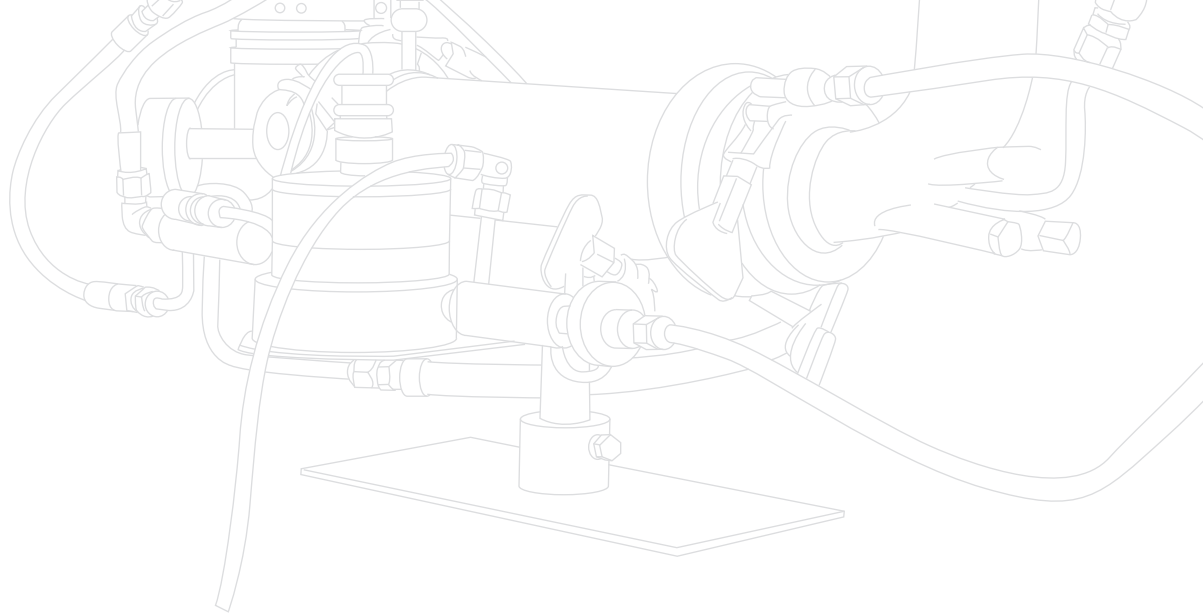

■ **Operator feedback**  
OK/NOK LEDs



■ **Reverse push button**  
Multi function

■ **Highly reliable**  
Long life gears and zero maintenance motor

■ **Superior ergonomics**  
Small size and soft grip

■ **Improve joint visibility**  
LED headlights

### **Optimized for CVIC controller**

The CVIC can control 15 tool cycles of up to 15 phases each, enabling you to select the best tightening strategy for your application. For example, you can increase the approach and reduce the final speeds to improve cycle time while maintaining tightening accuracy. You can also adjust torque speeds for self-tapping screws and verify angle positions to detect inaccurate tightening. The controller provides instant feedback to the operator via the LED OK/NOK lights.



# Electric Screwdrivers - CVIC

0.12 to 16 Nm (1.1 to 141.6 in.lb) - 840 to 2000 rpm

## Applications

Desoutter ECS Series screwdrivers are recommended for light and precision assembly applications in a wide range of industries, including appliances, medical equipment, electronics and motor vehicle systems.



PIC REF	MODEL	PART NUMBER	OUTPUT DRIVE	TORQUE RANGE				ROTATIONAL SPEED 130%	LENGTH		WEIGHT	
				MIN.	MAX.	MIN.	MAX.		mm	in.	kg	lb.
			in.	Nm	Nm	in.lb	in.lb	rpm				
<b>ELECTRIC SCREWDRIVERS - IN-LINE</b>												
	ECS06	615 165 442 0	Hex. 1/4 F	0.12	0.6	1.1	5.3	2000	285	11.2	0.6	1.3
	ECS2	615 165 443 0	Hex. 1/4 F	0.45	1.8	4.0	15.9	2000	285	11.2	0.6	1.3
<b>A</b>	ECS4	615 165 445 0	Hex. 1/4 F	1.00	4.0	8.8	35.4	2000	285	11.2	0.6	1.3
	ECS7	615 165 446 0	Hex. 1/4 F	1.90	7.5	16.8	66.4	1800	285	11.2	0.7	1.5
	ECS10	615 165 444 0	Hex. 1/4 F	2.50	10.0	22.1	88.5	1340	285	11.2	0.7	1.5
	ECS16*	615 165 459 0	Hex. 1/4 F	4.00	16.0	35.4	141.6	840	285	11.2	0.7	1.5
<b>ELECTRIC SCREWDRIVERS - SPINDLE</b>												
	ECS06-M20	615 165 454 0	Hex. 1/4 F	0.12	0.6	1.1	5.3	2000	285	11.2	0.6	1.3
	ECS2-M20	615 165 455 0	Hex. 1/4 F	0.45	1.8	4.0	15.9	2000	285	11.2	0.6	1.3
<b>B</b>	ECS4-M20	615 165 456 0	Hex. 1/4 F	1.00	4.0	8.8	35.4	2000	285	11.2	0.6	1.3
	ECS7-M20	615 165 457 0	Hex. 1/4 F	1.90	7.5	16.8	66.4	1800	285	11.2	0.7	1.5
	ECS10-M20	615 165 458 0	Hex. 1/4 F	2.50	10.0	22.1	88.5	1340	285	11.2	0.7	1.5
	ECS16-M20*	615 165 460 0	Hex. 1/4 F	4.00	16.0	35.4	141.6	840	285	11.2	0.7	1.5
<b>ELECTRIC SCREWDRIVERS - ANGLE HEAD</b>												
	ECSA2	615 165 447 0	Hex. 1/4 F	0.55	2.0	4.9	17.7	2000	329	12.9	0.6	1.3
<b>C</b>	ECSA7	615 165 448 0	Hex. 1/4 F	2.20	8.5	19.5	75.2	1800	329	12.9	0.7	1.5
	ECSA10	615 165 449 0	Hex. 1/4 F	3.00	11.5	26.6	101.8	1340	329	12.9	0.7	1.5

\* Available in 2009



# Accessories

## ACCESSORIES INCLUDED

- Fixed suspension bail

PART NO.  
205 049 537 3

## OPTIONAL ACCESSORIES

ITEM

- 1 Reaction handle
- **Spring loaded Shafts and Bearings Support (including 2, 3, 4)**
- 2 Bit adaptor
- 3 Spring loaded Shaft 25mm (1") stocke, 3/8" Sq drive
- 4 Shaft Support and Nose mount
- 5 Nose mounts
- Flange M20
- 6 Offset Head, Offset 30mm (1.18")
- 7 Spring Loaded Shaft 25mm (1") stroke, 3/8 Sq Drive
- 8 3/8" Square to 1/4" Hex Power Adaptor

PART NO.  
615 397 016 0  
103782  
108342  
108412  
205 052 876 3  
205 052 875 3  
384993  
108342  
108322

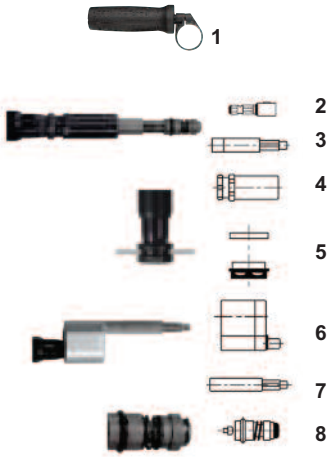









# Controllers - CVIC



MODEL	PART NUMBER	CONSUMPTION (current)		MAIN SUPPLY	WIDTH		DIMENSIONS HEIGHT		DEPTH		WEIGHT	
		115V	230V		mm	in.	mm	in.	mm	in.	kg	lb.
CVIC L-2	615 932 608 0	4A	2A	Single-phase	260	10.2	270	10.6	170	6.7	5	11.0
CVIC H-2	615 932 610 0	4A	2A	100 to 250 V	260	10.2	270	10.6	170	6.7	5	11.0

**START-UP KIT** to be ordered with the controller  
Including: **Plug + Literature + Connector**

PLUG	LITERATURE	PART NO.
	A French	615 928 040 0
	C English	615 928 041 0
	A English	615 928 046 0
	B English	615 928 049 0
	A German	615 928 042 0
	A Spanish	615 928 043 0
	D Italian	615 928 044 0
	A Dutch	615 928 048 0
	A Swedish	615 928 045 0



## OPTIONAL ACCESSORIES

PART NO.  
PC cable, lenght 2 m (78.7") 615 917 047 0  
Printer cable, lenght 2 m (78.7") 615 917 011 0

# The Posco 500 System

## ACHIEVE HIGHER ASSEMBLY QUALITY

**Water-tight gaskets. Rattle-free dashboards. Precision-aligned circuit boards. Fragile plastic flanges. Fastening tasks like these and many others require highly accurate tightening.**

### Cost-effective error proofing

The Desoutter Posco 500 system enables different operators to execute the same assembly process with the same level of quality, according to Poka Yoke (error proofing) principles. Comprised of a control unit and encoder equipped tool stand, the Posco 500 system ensures that operators perform tightening operations in the right sequence at the right torque, with the right tool in the right position. One of the unique features of the Posco system is the use of absolute encoders for determining the X and Y positions. With this technology, there is no need to calibrate the positioning coordinates. Conventional encoders have to be calibrated on regular basis, commonly on a daily basis.

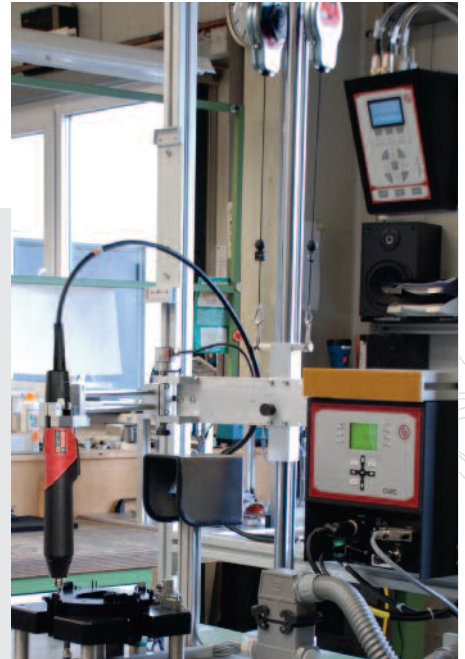

### Increased operator versatility

The Posco 500 system opens the door to highly flexible and cost-effective assembly quality. Because it guides the operator step by step, it reduces the amount of training each operator requires and allows operators to move between operations without implications quality levels. Moreover, it eliminates the rework costs associated with repairing incorrectly assembled products.

For maximum productivity and quality, the Posco 500 can provide operator guidance with the LED Module, which offers active LEDs according to the part bolt pattern.

### Easy programming

The Posco 500 system lets you program a sequence of operations by "Self learning mode" and make sure that the steps are completed in the right order and in the right conditions. It can be programmed for 64 separate jobs, each with up to 800 separate steps. The Posco configuration can be made on Posco 500 or by PC.

### Flexibility and control

Using the Posco 500 system with the D-series arms and X and Y positioning encoders, the tool will always be in the correct position for the fastening operation. The ability to use digital input and output signals will confirm to your line PLC that the job is done. Used in conjunction with a Posco 500 tool stand, the control unit ensures that the tool is positioned properly during the operation.



# Posco 500 Error-Proofing Control Unit

## Posco 500 control Unit

- Memory capacity: 64 jobs (components/assignments) programmed manually or externally
- Sequence capacity: 800 steps/positions, 10 inputs and 6 outputs standard. (Option: 20 input and 12 outputs)
- RS232 interface (basic version) with link to PC and/or reader/scanner
- Free sequence programming
- Unlimited number or kinds of tools can be integrated into the sequence
- Professional programming with text display for worker guidance (optional)
- Optional FAS module tightening monitor for pneumatic fastening
- Optional PC and barcode modules

## Posco 500 Tool Stand

- Absolute value measuring: impossible to lose positions
- Non-contact measurement without toothed belts, i.e. no wear
- High measuring accuracy: Horizontal  $\pm 0.3$  mm, Axis of rotation  $\pm 0.46$  mm

## Bit Tray

- Two operating modes: Posco 500 or fastener control program
- 1/4" hex. drive for 6 bits\*
- Connect up to 5 modules in series
- Control via digital 24V I/O interface
- Compatible with Posco 500, (TWIN) CVI, CVIS, CVIC

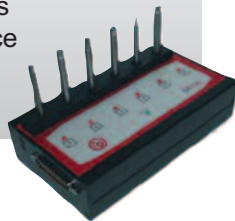

POSCO 500	PART NO.
• Posco 500 desk	615 932 656 0
• Posco 500 wall	615 932 657 0
• Posco 500 desk + I/O exp.	615 932 658 0
• Posco 500 wall + I/O exp.	615 932 659 0

ACCESSORIES	PART NO.
• Power supply 1.2A	615 936 047 0
• Mounting set	615 930 777 0
• Bittray	615 929 025 0
• Cable Posco-Bittray/Ter.box - Lenght 2m	615 917 533 0
• Cable Posco/Ter.box-CVI - Lenght 2m	615 917 534 0
• Cable Bittray-CVI - Lenght 2m	615 917 535 0
• Y cable RS232	615 917 536 0
• FAS module	615 936 048 0
• Barcode reader	615 927 571 0
• Advanced programming Licence	615 927 572 0
• PC Software	615 927 573 0

STANDS	PART NO.
• D53 X-axis	615 396 931 0
• D53 Y-axis	615 396 932 0
• D53 X/Y-axis	615 396 933 0
• D53-70 X-axis	615 396 934 0
• D53-70 Y-axis	615 396 935 0
• D53-70 X/Y-axis	615 396 936 0
• D60 arm with no encoder	61144
• D60 arm with 2 encoders	61147

TYPE	D53	D53-70	D60
Pivot range	360°	360°	360°
Extension lenght	300 mm (11.8")	440 mm (17.3")	300 mm (11.8")
Reach	510 mm (20.1")	600 mm (23.6")	622 mm (24.5")
Height	1130 mm (44.5")	1140 mm (44.9")	1130 mm (44.5")
Max. capacity	2.5 kg (5.5 lb)	3.5 kg (7.76 lb)	2.5 kg (5.5 lb)
Max.torque	16 Nm (11.8 ft.lb)	70 Nm (51.6")	25 Nm (18.4 ft.lb)

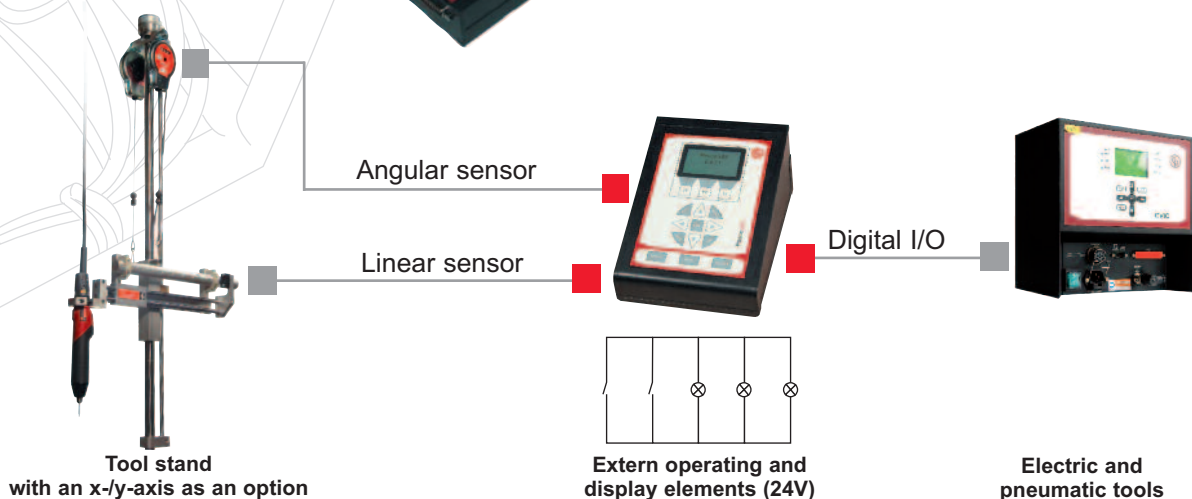

## Tools and Controllers

The Posco 500 system integrates seamlessly with the Desoutter CVIC or CVI II controller ranges. All torque programs are automatically retrieved from the Posco 500 unit, ensuring the right program at the right screw in the right sequence.

# More Than Productivity



[www.desouttertools.com](http://www.desouttertools.com)

English 615 993 384 1  
© Copyright 2008 CP

Printed in France November 2008 - Issue 1